

Corners
&
Rounds

Drawings may not be to scale

RBP #602
(3/8 X 3/4)



RBP #639
(1/2 X 1)



RBP #626
(5/8 X 1-1/4)



RBP #607
(3/4 X 1-1/2)

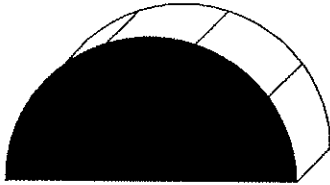

RBP #658
(7/8 X 1-3/4)

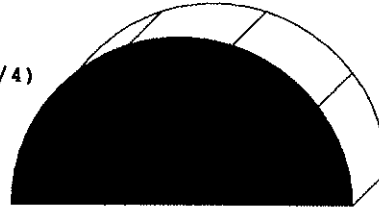

RBP #629
(1 X 2)

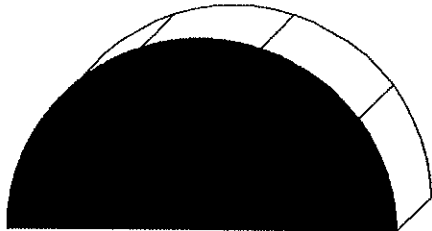

RBP #608
(1-1/2 X 3)

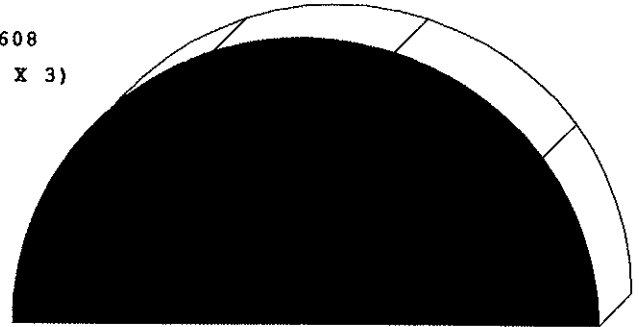

RBP #640
(1-1/4 X 2)

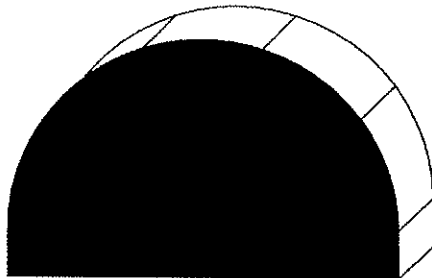

RBP #604
(2 X 2-1/2)

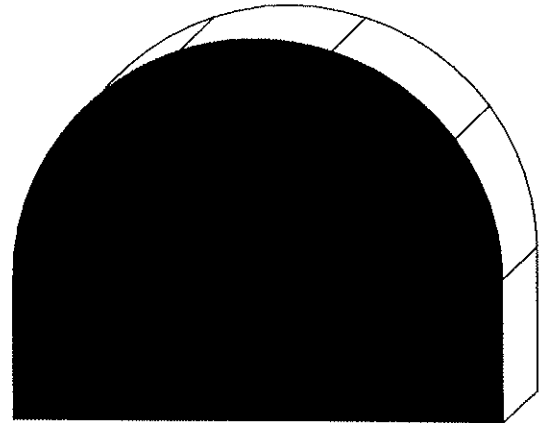

RBP #655
(3/4 X 3/4)

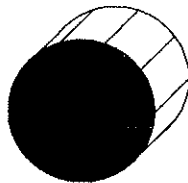

RBP #656
(1 X 1)

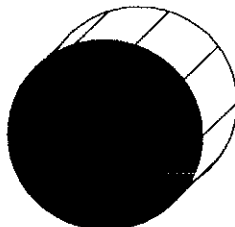

RBP #644
(1-1/4 X 1-1/4)

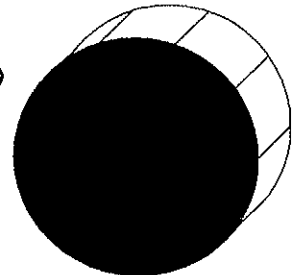

CORNER & ROUND MOULDINGS

RBP #646
(2 X 2)

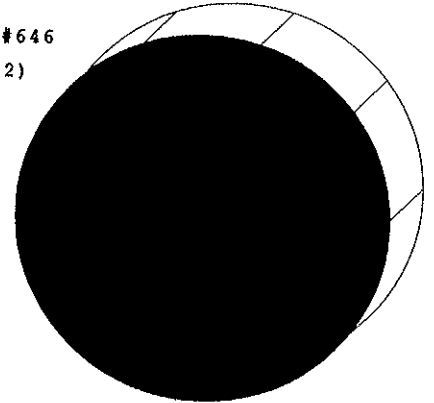

RBP #619
(1-3/8 X 1-3/8)

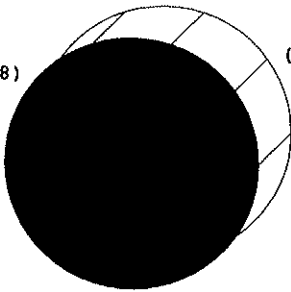

RBP #621
(1-1/2 X 1-1/2)

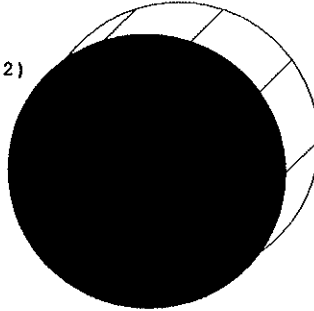

RBP #627
(1/2 X 3/4)

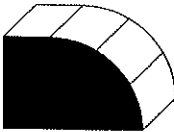

RBP #624
(3/4 X 3/4)

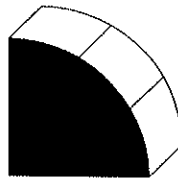

RBP #637
(1 X 1)

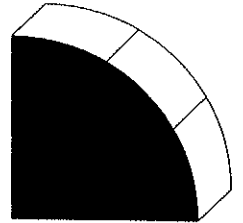

RBP #606
(1-1/2 X 1-1/2)

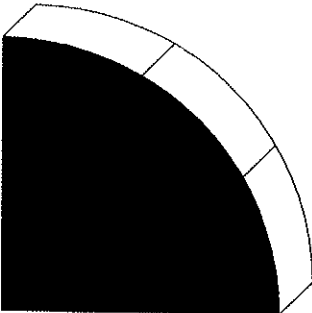

RBP #605
(1-1/2 X 2-1/2)

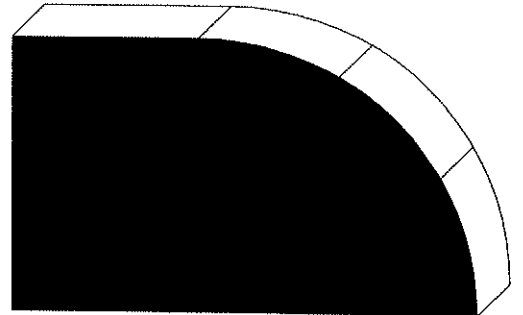

RBP #622
(1 X 1)

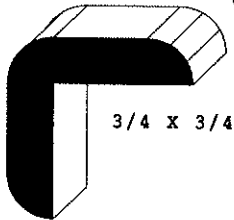

RBP #623
(1-1/4 X 1-1/4)

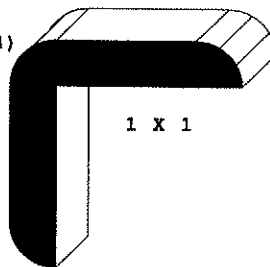

RBP #613
(1-1/2 X 1-1/2)

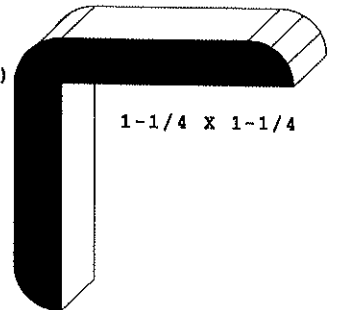

RBP #618
(1-1/8 X 1-1/8)

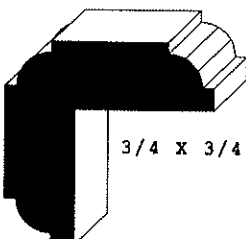

RBP #611
(1-5/8 X 1-5/8)

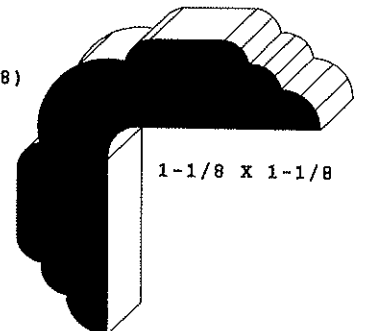

RBP #634
(2 X 2)

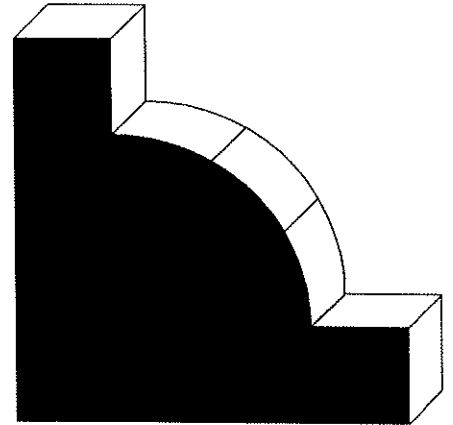

RBP #614
(3/4 X 3/4)



RBP #600
(3/4 X 3/4)

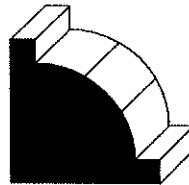

RBP #603
(3/4 X 3/4)

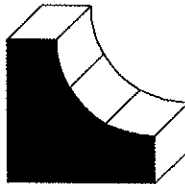

RBP #647
(1 X 1)

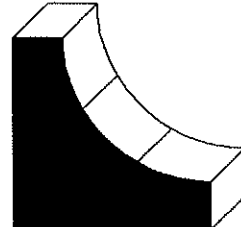

RBP #601
(1-3/8 X 1-3/8)

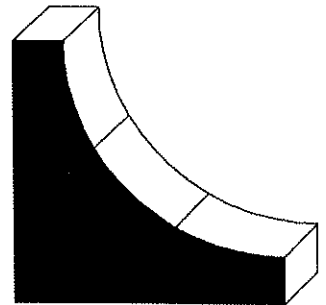

RBP #615
(1/4 X 3/4)



RBP #620
(1/4 X 7/8)

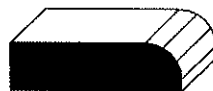

RBP #654
(1/4 X 3/4)



RBP #616
(1/4 X 1-1/2)



RBP #652
(1/2 X 1-1/2)

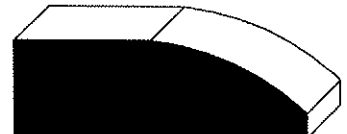

RBP #659
(1-1/2 X 1-1/2)

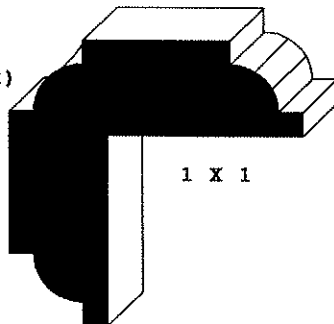

1 X 1

RBP #661
(1-3/4 X 1-3/4)

